

SAUF INDICATION CONTRAIRE:  
LES COTES SONT EN MILLIMETRES  
ETAT DE SURFACE:  
TOLERANCES:  
LINEAIRES:  
ANGULAIRES:

FINITION:

CASSER LES  
ANGLES VIFS

NE PAS CHANGER L'ECHELLE

REVISION

NOM	SIGNATURE	DATE			
AUTEUR					
VERIF.					
APPR.					
FAB.					
QUAL.					

TITRE:	
No. DE PLAN	<b>Vue Globale</b>
ECHELLE:1:50	FEUILLE 1 SUR 1
	A4

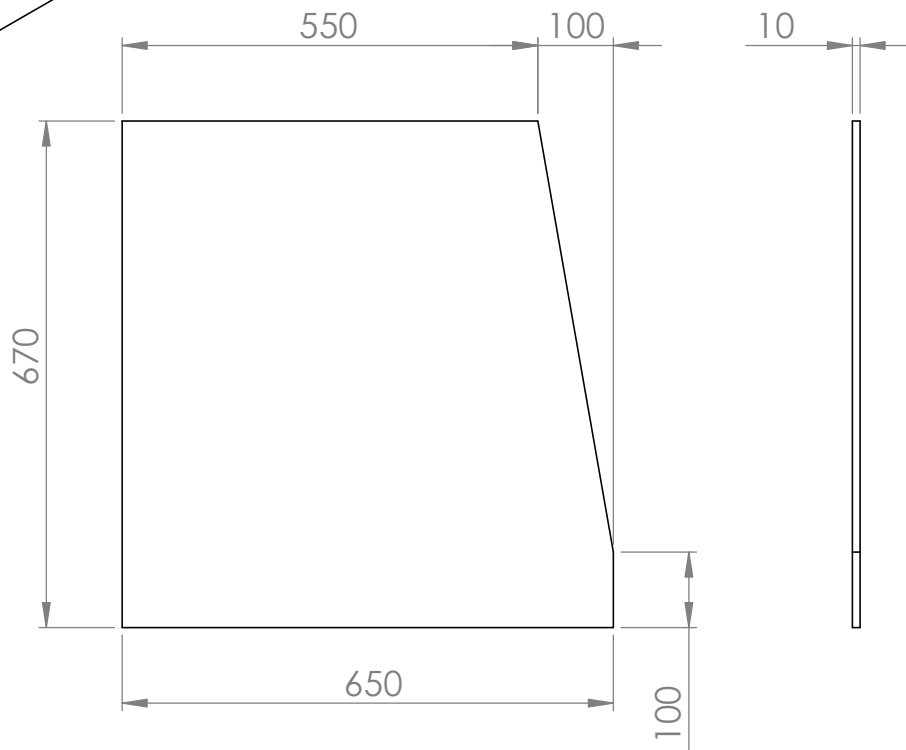
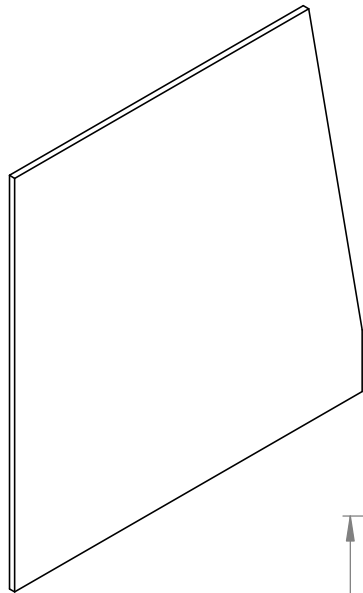

SAUF INDICATION CONTRAIRE:  
LES COTES SONT EN MILLIMETRES  
ETAT DE SURFACE:  
TOLERANCES:  
LINEAIRES:  
ANGULAIRES:

FINITION:

CASSER LES  
ANGLES VIFS

NE PAS CHANGER L'ECHELLE

REVISION

	NOM	SIGNATURE	DATE			
AUTEUR						
VERIF.						
APPR.						
FAB.						
QUAL.						
				MATERIAU:		
				MASSE:		

TITRE:	
No. DE PLAN	<b>Rack Gauche</b>
	A4
ECHELLE:1:50	FEUILLE 1 SUR 1

coté

base

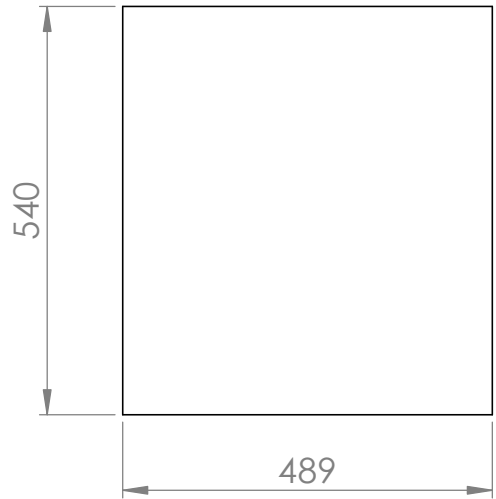
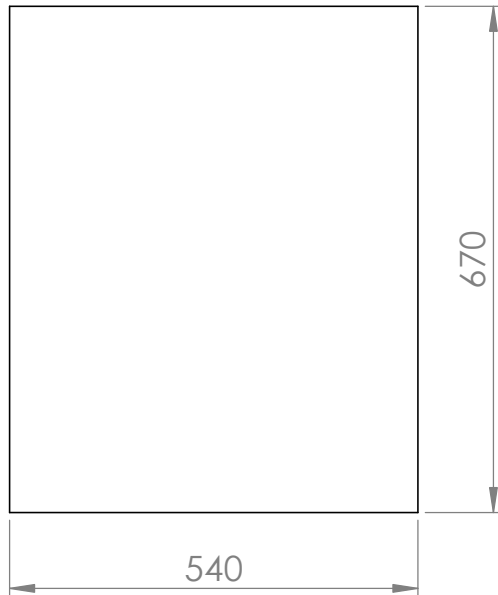
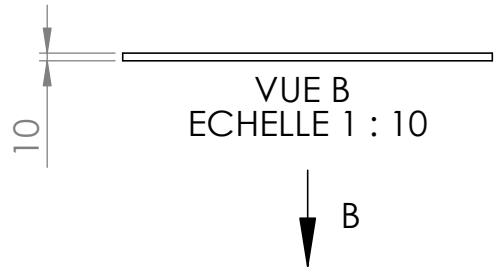
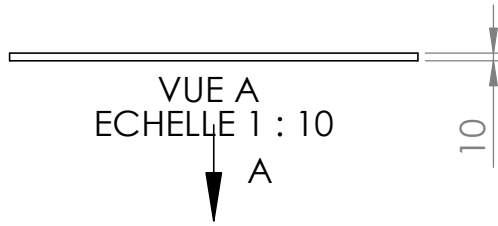

SAUF INDICATION CONTRAIRE: LES COTES SONT EN MILLIMETRES ETAT DE SURFACE: TOLERANCES: LINEAIRES: ANGULAIRES:		FINITION:		CASSER LES ANGLES VIFS		NE PAS CHANGER L'ECHELLE		REVISION	
coté									
NOM	SIGNATURE	DATE				TITRE:			
AUTEUR						<h1>Caisson Droit</h1>			
VERIF.									
APPR.									
FAB.									
QUAL.				MATERIAU:		No. DE PLAN			A4
				MASSE:		ECHELLE:1:50	FEUILLE 1 SUR 1		

plateau milieu

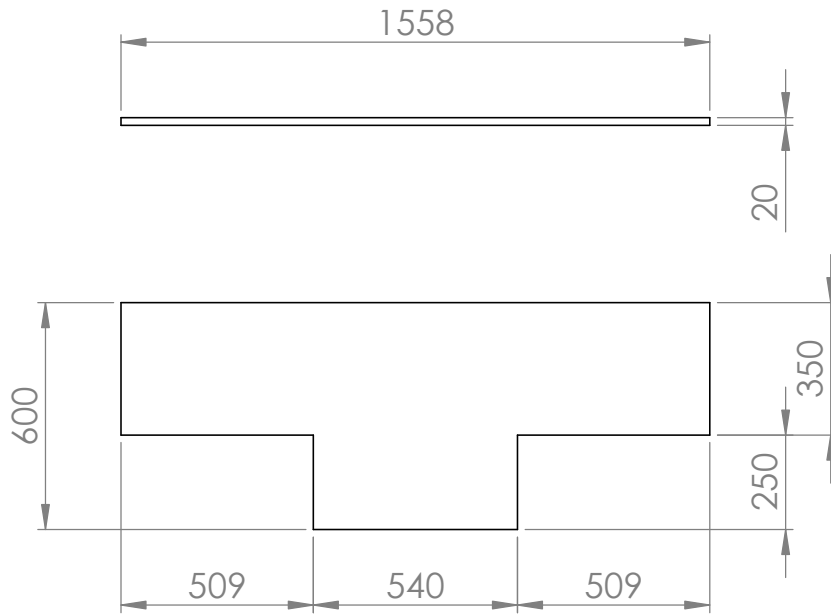

plateau racks haut

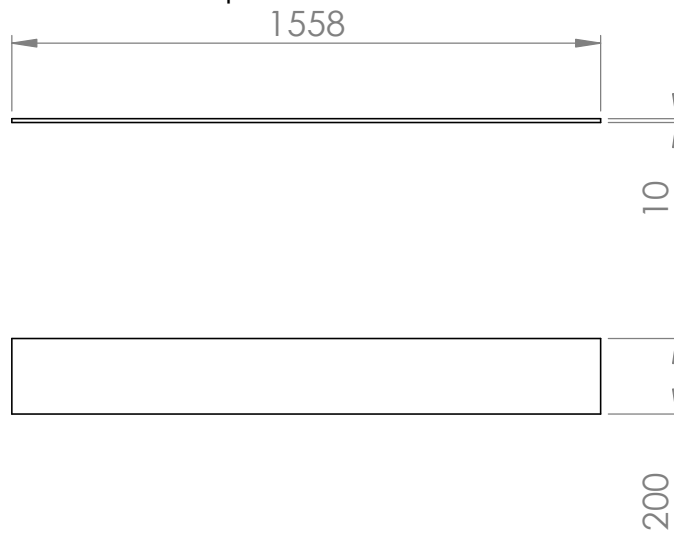

SAUF INDICATION CONTRAIRE: LES COTES SONT EN MILLIMETRES ETAT DE SURFACE: TOLERANCES: LINEAIRES: ANGULAIRES:		FINITION:		CASSER LES ANGLES VIFS		NE PAS CHANGER L'ECHELLE		REVISION	
NOM		SIGNATURE		DATE		TITRE:			
AUTEUR						<p>No. DE PLAN</p> <h1 style="text-align: center;">Plateaux</h1>			
VERIF.									
APPR.									
FAB.									
QUAL.				MATERIAU:		ECHELLE:1:50		FEUILLE 1 SUR 1	
				MASSE:				A4	

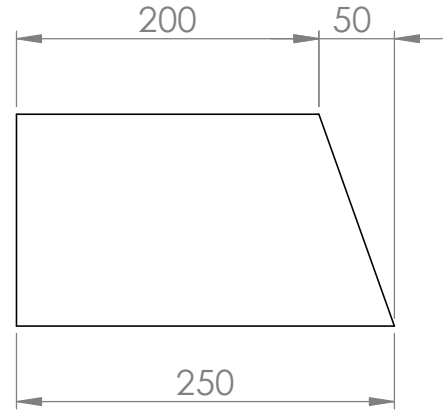
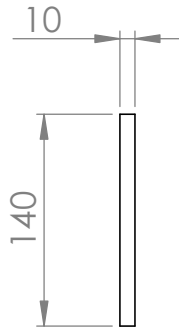
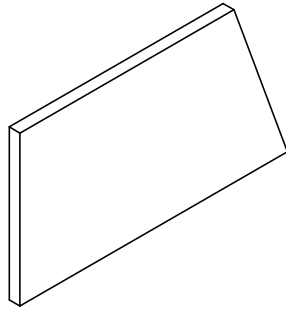

SAUF INDICATION CONTRAIRE: LES COTES SONT EN MILLIMETRES ETAT DE SURFACE: TOLERANCES: LINEAIRES: ANGULAIRES:		FINITION:		CASSER LES ANGLES VIFS		NE PAS CHANGER L'ECHELLE		REVISION	
NOM		SIGNATURE		DATE		TITRE:			
AUTEUR						No. DE PLAN			
VERIF.									
APPR.									
FAB.									
QUAL.				MATERIAU:		Racks Haut		A4	
				MASSE:		ECHELLE:1:50		FEUILLE 1 SUR 1	

Rack gauche  
Face avant bas

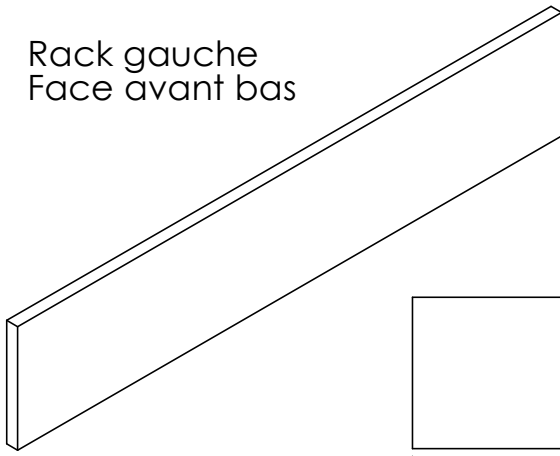

Rack et caisson  
Supports interne

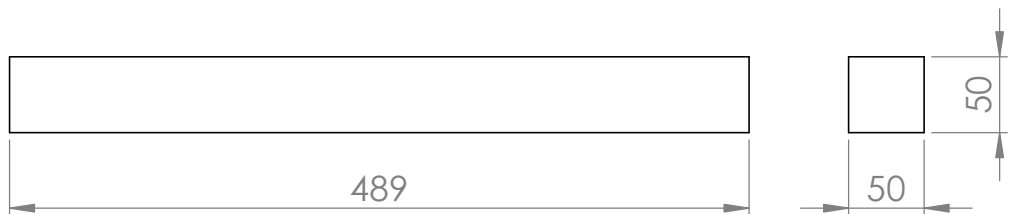
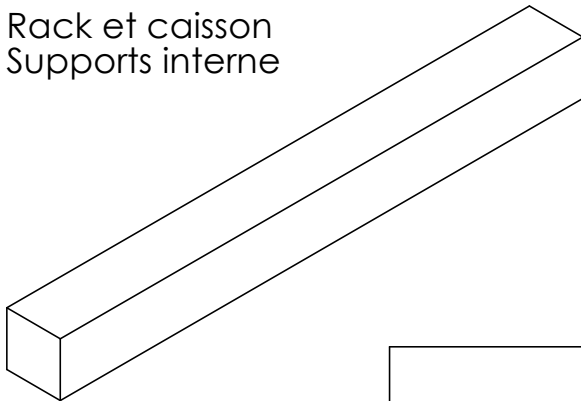

SAUF INDICATION CONTRAIRE:  
LES COTES SONT EN MILLIMETRES  
ETAT DE SURFACE:  
TOLERANCES:  
LINEAIRES:  
ANGULAIRES:

FINITION:

CASSER LES  
ANGLES VIFS

NE PAS CHANGER L'ECHELLE

REVISION

	NOM	SIGNATURE	DATE			
AUTEUR						
VERIF.						
APPR.						
FAB.						
QUAL.						
				MATERIAU:		
				MASSE:		

TITRE:

No. DE PLAN

Barres diverses

A4

ECHELLE:1:50

FEUILLE 1 SUR 1